

**STANDBY POWER RATING**

150 kW, 188 kVA, 60 Hz

**PRIME POWER RATING\***

135 kW, 169 kVA, 60 Hz

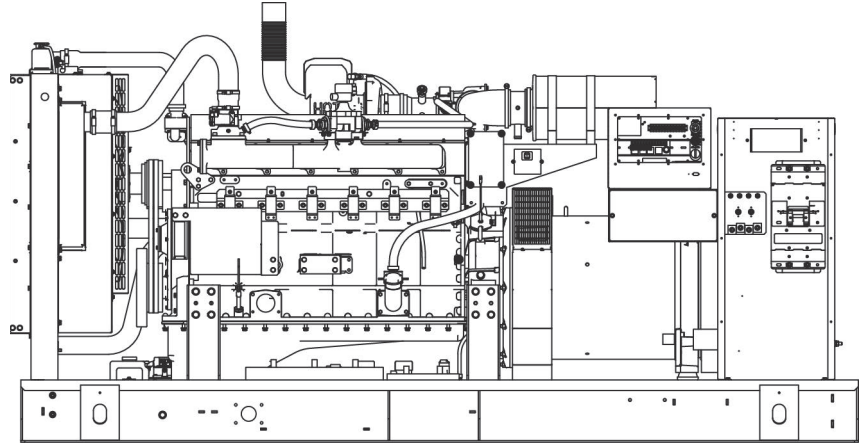

\*Built in the USA using domestic and foreign parts

\*EPA Certified Prime ratings are not available in the U.S. or its Territories.

Image used for illustration purposes only

**CODES AND STANDARDS**

Generac products are designed to the following standards:

 UL2200, UL508, UL142, UL498

 NFPA70, 99, 110, 37

 NEC700, 701, 702, 708

 ISO9001, 8528, 3046, 7637, Pluses #2b, 4

 NEMA ICS10, MG1, 250, ICS6, AB1

 **ANSI**  
 American National Standards Institute  
 ANSI C62.41

 **ICC** **osHPD**  
 IBC 2009, CBC 2010, IBC 2012, ASCE 7-05,  
 ASCE 7-10, ICC-ES AC-156 (2012)

**POWERING AHEAD**

For over 50 years, Generac has led the industry with innovative design and superior manufacturing.

Generac ensures superior quality by designing and manufacturing most of its generator components, including alternators, enclosures and base tanks, control systems and communications software.

Generac's gensets utilize a wide variety of options, configurations and arrangements, allowing us to meet the standby power needs of practically every application.

Generac searched globally to ensure the most reliable engines power our generators. We choose only engines that have already been proven in heavy-duty industrial application under adverse conditions.

Generac is committed to ensuring our customers' service support continues after their generator purchase.

## STANDARD FEATURES

### ENGINE SYSTEM

#### General

- Oil Drain Extension
- Air Cleaner
- Fan Guard
- Stainless Steel flexible exhaust connection
- Critical Exhaust Silencer
- Factory Filled Oil & Coolant
- Radiator Duct Adapter (open set only)

#### Fuel System

- Primary and secondary fuel Shutoff

#### Cooling System

- Closed Coolant Recovery System
- UV/Ozone resistant hoses
- Factory-Installed Radiator
- 50/50 Ethylene glycol antifreeze
- Radiator drain extension

#### Engine Electrical System

- Battery charging alternator
- Battery cables
- Battery tray
- Solenoid activated starter motor
- Rubber-booted engine electrical connections

### ALTERNATOR SYSTEM

- UL2200 GENprotect™
- Class H insulation material
- 2/3 Pitch
- Skewed Stator
- Permanent Magnet Excitation
- Sealed Bearings
- Amortisseur winding
- Full load capacity alternator

### GENERATOR SET

- Internal Genset Vibration Isolation
- Separation of circuits—high/low voltage
- Separation of circuits—multiple breakers
- Wrapped Exhaust Piping (enclosed Units only)
- Standard Factory Testing
- 2 Year Limited Warranty (Standby rated Units)
- 1 Year Limited Warranty (Prime rated units)
- Silencer mounted in the discharge hood (enclosed only)

### ENCLOSURE (IF SELECTED)

- Rust-proof fasteners with nylon washers to protect finish
- High performance sound-absorbing material
- Gasketed doors
- Stamped air-intake louvers
- Air discharge hoods for radiator-upward pointing
- Stainless steel lift on door hinges
- Stainless steel lockable handles
- Rhino Coat™ - Textured polyester powder coat

### CONTROL SYSTEM

#### Control Panel

- Digital G-200 Paralleling Control Panel - Touch-Screen
- Programmable Crank Limiter
- 7-Day Programmable Exerciser
- Special Applications Programmable PLC
- RS-232/485
- All-Phase Sensing DVR
- Full System Status
- Low Fuel Pressure Indication
- 2-Wire Start Compatible
- Power Output (kW)
- kW Hours, Total
- Real/Reactive/Apparent Power
- All Phase AC Voltage
- All Phase Currents
- Oil Pressure
- Coolant Temperature
- Coolant Level
- Engine Speed
- Battery Voltage

- Frequency
- Date/Time Fault History (Event Log)
- Isochronous Governor Control
- Waterproof/sealed Connectors
- Audible Alarms and Shutdowns
- Not in Auto (Flashing Light)
- Auto/O/Manual Switch
- E-Stop (Red Mushroom-Type)
- Customizable Alarms, Warnings, and Events
- Modbus protocol
- Predictive Maintenance algorithm
- Sealed Boards
- Password parameter adjustment protection
- Single point ground
- 15 channel data logging
- 0.2 msec high speed data logging
- Alarm information automatically comes up on the display

#### Alarms

- Oil Pressure (Pre-programmable Low Pressure Shutdown)
- Coolant Temperature (Pre-programmed High Temp Shutdown)
- Coolant Level (Pre-programmed Low Level Shutdown)
- Low Fuel Pressure Alarm
- Engine Speed (Pre-programmed Over speed Shutdown)
- Battery Voltage Warning
- Alarms & warnings time and date stamped
- Alarms & warnings for transient and steady state conditions
- Snap shots of key operation parameters during alarms & warnings
- Alarms and warnings spelled out (no alarm codes)

### PARALLELING CONTROLS

- Auto-synchronization process
- Isochronous load sharing
- Reverse power protection
- Maximum power protection
- Electrically operated, mechanically held paralleling switch
- Sync check system
- Independent on-board paralleling
- Optional programmable logic full auto back-up control (pls)
- Shunt Trip and Auxiliary contact

# MG150 | 14.2L | 150 kW

## INDUSTRIAL SPARK-IGNITED GENERATOR SET

EPA Certified Stationary Emergency

### CONFIGURABLE OPTIONS

---

#### ENGINE SYSTEM

General

- Flexible Fuel Line - NPT connection
- Oil Heater
- Air Filter Restriction Indicator
- Stone Guard (Open Set Only)

Fuel Electrical System

- 10A UL battery charger
- Battery Warmer

#### ALTERNATOR SYSTEM

- Alternator Upsizing
- Anti-Condensation Heater
- Tropical Coating

#### CIRCUIT BREAKER OPTIONS

- Main Line Circuit Breaker
- Electronic Trip Breaker

#### GENERATOR SET

- Gen-Link Communications Software (English Only)
- Extended Factory Testing
- 8 Position Load Center
- 2 Year Extended Warranty
- 5 Year Warranty
- 5 Year Extended Warranty

#### ENCLOSURE

- Standard Enclosure
- Level 1 Sound Attenuation
- Level 2 Sound Attenuation
- Steel Enclosure
- Aluminum Enclosure
- 12 VDC Enclosure Lighting Kit
- 120 VAC Enclosure Lighting Kit
- AC/DC Enclosure Lighting Kit

#### CONTROL SYSTEM

- 21-Light Remote Annunciator
- Remote Relay Board (8 or 16)
- Oil Temperature Sender with Indication Alarm
- Remote E-Stop (Break Glass-Type, Surface Mount)
- Remote E-Stop (Red Mushroom-Type, Surface Mount)
- Remote E-Stop (Red Mushroom-Type, Flush Mount)
- Remote Communication - Ethernet
- 10A Run Relay,
- Ground Fault Indication and Protection
- Functions

### ENGINEERED OPTIONS

---

#### ENGINE SYSTEM

- Fluid containment Pans
- Coolant heater ball valves

#### CONTROL SYSTEM

- Battery Disconnect Switch

#### GENERATOR SET

- Special Testing
- Battery Box

#### ENCLOSURE

- Motorized Dampers
- Enclosure Ambient Heaters
- Door Alarm Switch
- 150 MPH Wind Kit

### RATING DEFINITIONS

**Standby** - Applicable for a varying emergency load for the duration of a utility power outage with no overload capability.

**Prime** - Applicable for supplying power to a varying load in lieu of utility for an unlimited amount of running time. A 10% overload capacity is available for 1 out of every 12 hours. The Prime Power option is only available on International applications. Power ratings in accordance with ISO 8528-1, Second Edition

# MG150 | 14.2L | 150 kW

## INDUSTRIAL SPARK-IGNITED GENERATOR SET

EPA Certified Stationary Emergency

### APPLICATION AND ENGINEERING DATA

#### ENGINE SPECIFICATIONS

##### General

Make	Generac
Cylinder #	6
Type	In-line
Displacement - L (cu In)	14.17 (864.71)
Bore - mm (in)	135 (5.31)
Stroke - mm (in)	165 (6.50)
Compression Ratio	9.5:1
Intake Air Method	Turbocharged/Aftercooled
Number of Main Bearings	7
Connecting Rods	Carbon Steel
Cylinder Head Type	Cast Iron GT250, OHV
Cylinder Head	Ductile Iron
Cylinder Liners	Altronic CD1
Piston Type	Aluminum
Crankshaft Type	Ductile Iron
Lifter Type	Solid
Intake Valve Material	Special Heat-Resistant Steel
Exhaust Valve Material	Alloy Steel, High Temp
Hardened Valve Seats	Alloy Steel, High Temp

##### Engine Governing

Governor	Electronic
Frequency Regulation (Steady State)	+/- 0.25%

##### Lubrication System

Oil Pump Type	Gear
Oil Filter Type	Full-Flow Cartridge
Crankcase Capacity - L (qts)	34.3 (36.2)

##### Cooling System

Cooling System Type	Pressurized Closed Recovery
Water Pump Flow -gpm (lpm)	110 (416)
Fan Type	Pusher
Fan Speed (rpm)	1894
Fan Diameter mm (in)	762 (30)
Coolant Heater Wattage	2000
Coolant Heater Standard Voltage	240 V

##### Fuel System

Fuel Type	Natural Gas
Carburetor	Down Draft
Secondary Fuel Regulator	Standard
Fuel Shut Off Solenoid	Standard
Operating Fuel Pressure (Standard)	7" - 11" H <sub>2</sub> O

##### Engine Electrical System

System Voltage	24 VDC
Battery Charging Alternator	Standard
Battery Size	See Battery Index 0161970SBY
Battery Voltage	(2)12 VDC
Ground Polarity	Negative

#### ALTERNATOR SPECIFICATIONS

Standard Model	520mm
Poles	4
Field Type	Revolving
Insulation Class - Rotor	H
Insulation Class - Stator	H
Total Harmonic Distortion	<5%
Telephone Interference Factor (TIF)	<50

Standard Excitation	Permanent Magnet
Bearings	Sealed Ball
Coupling	Direct, Flexible Disc
Prototype Short Circuit Test	Yes
Voltage Regulator Type	Full Digital
Number of Sensed Phases	3
Regulation Accuracy (Steady State)	±0.25%

# MG150 | 14.2L | 150 kW

## INDUSTRIAL SPARK-IGNITED GENERATOR SET

EPA Certified Stationary Emergency

### OPERATING DATA

#### POWER RATINGS

		Natural Gas
Three-Phase 120/208 VAC @0.8pf	150 kW	Amps: 521
Three-Phase 120/240 VAC @0.8pf	150 kW	Amps: 452
Three-Phase 277/480 VAC @0.8pf	150 kW	Amps: 226
Three-Phase 347/600 VAC @0.8pf	150 kW	Amps: 181

#### STARTING CAPABILITIES (sKVA)

sKVA vs. Voltage Dip

Alternator	kW	480 VAC						208/240 VAC					
		10%	15%	20%	25%	30%	35%	10%	15%	20%	25%	30%	35%
Standard	150	133	199	265	332	398	464	100	149	199	249	299	348
Upsize 1	200	187	280	373	467	560	653	140	210	280	350	420	490

#### FUEL CONSUMPTION RATES\*

Natural Gas - ft<sup>3</sup>/hr(m<sup>3</sup>/hr)

Percent Load	Standby
25%	745 (21.1)
50%	1278 (36.2)
75%	1725 (48.8)
100%	2129 (60.3)

\* Fuel supply installation must accommodate fuel consumption rates at 100% load.

#### COOLING

		Standby
Air Flow (inlet air combustion and radiator)	ft <sup>3</sup> /min(m <sup>3</sup> /min)	9349 (264.7)
Coolant Flow per Minute	g/min (l/min)	110 (416)
Heat Rejection to Coolant	BTU/hr	526,760
Max. Operating Air Temp on Radiator	°F (°C)	122 (50)
Max. Operating Ambient Temperature (before derate)	°F (°C)	110 (43.3)
Maximum Radiator Backpressure	in H <sub>2</sub> O	0.5

#### COMBUSTION AIR REQUIREMENT

	Standby
Flow at Rated Power cfm (m <sup>3</sup> /min)	349 (9.9)

#### ENGINE

		Standby
Rated Engine Speed	rpm	1800
Horsepower at Rated kW**	hp	238
Piston Speed	ft/min	1949 (594)
BMEP	psi	121

#### EXHAUST

		Standby
Exhaust Flow (Rated Output)	cfm (m <sup>3</sup> /min)	1203 (34.1)
Max. Backpressure (Post Turbo)	inHg (Kpa)	0.75
Exhaust Temp (Rated Output - post silencer)	°F (°C)	1350 (732)
Exhaust Outlet Size (Open Set)	(in)	3.5" I.D .Flex (No Silencer)

\*\* Refer to "Emissions Data Sheet" for maximum bHP for EPA and SCAQMD permitting purposes.

Deration – Operational characteristics consider maximum ambient conditions. Derate factors may apply under atypical site conditions. Please consult a Generac Power Systems Industrial Dealer for additional details. All performance ratings in accordance with ISO3046, BS5514, ISO8528 and DIN6271 standards.

**DIMENSIONS AND WEIGHTS\***

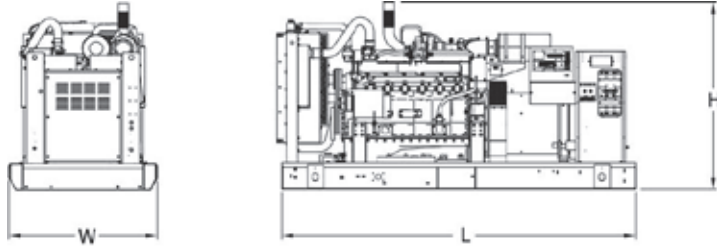

**OPEN SET (Includes Exhaust Flex)**

L x W x H (in (mm))	127.95 (3250) x 52.93 (1344.5) x 67.37 (1711.2)
Weight lbs (kg)	5756 (2610.9)

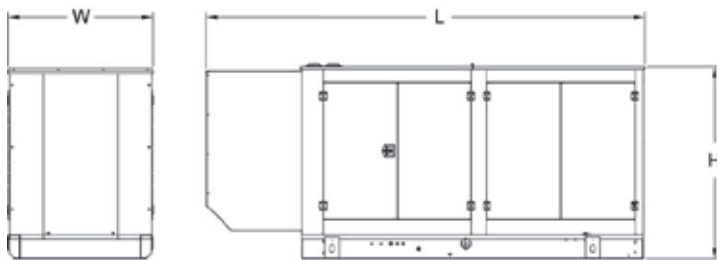

**STANDARD ENCLOSURE**

L x W x H (in (mm))	153.89 (3909) x 52.73 (1339.3) x 69.67 (1769.6)
Weight lbs (kg)	Steel: 6577 (2983) Aluminum: 6035 (2738)

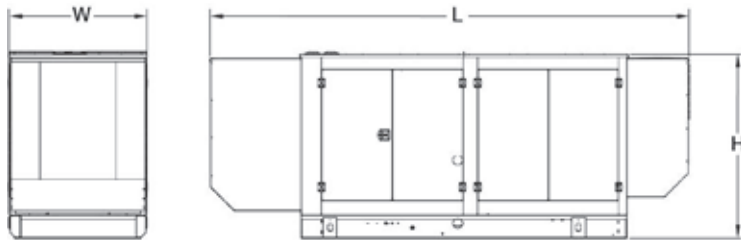

**LEVEL 1 ACOUSTIC ENCLOSURE**

L x W x H (in (mm))	180.11 (4574.7) x 52.73 (1339.3) x 69.67 (1769.6)
Weight lbs (kg)	Steel: 6990 (3171) Aluminum: 6176 (2801)

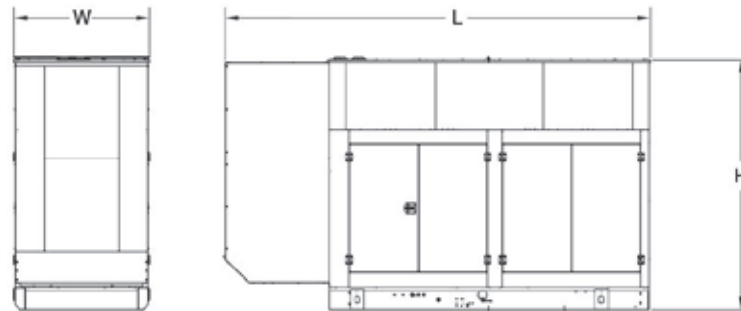

**LEVEL 2 ACOUSTIC ENCLOSURE**

L x W x H (in (mm))	154.45 (3922.9) x 53.96 (1370.6) x 93.40 (2372.3)
Weight lbs (kg)	Steel: 7236 (3282) Aluminum: 6259 (2839)

\* All measurements are approximate and for estimation purposes only.

**YOUR FACTORY RECOGNIZED GENERAC INDUSTRIAL DEALER**

Specification characteristics may change without notice. Please consult a Generac Power Systems Industrial Dealer for detailed installation drawings.